

INSTALLATION INSTRUCTIONS



Floor Mount Roller DOOR GUIDE

Best for applications in which no mortise along the length of the door bottom is desired. This guide is best used in a pair (one in front of the door and one behind it) to ensure the door does not sway in or out.



PARTS AND TOOLS

INSTALLATION INSTRUCTIONS

Dimensions

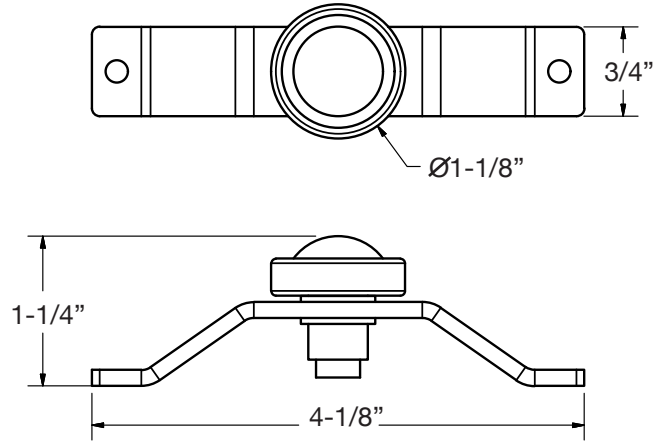

Tools Needed

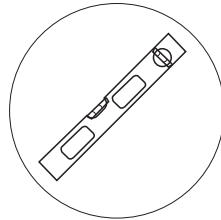

Short Level

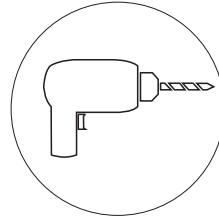

Drill with Phillips bit

Parts Included

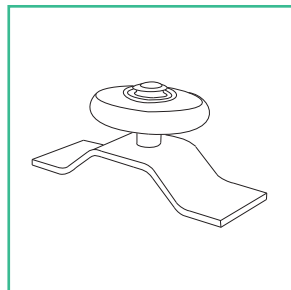

Door Guide

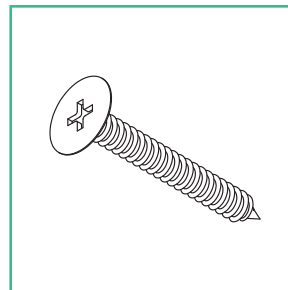

Grabber Screws



DOOR GUIDE

INSTALLATION INSTRUCTIONS

1. Installing Your Door Guides

- Place the Door Guides on your floor, about where you think they should be. Align the ends with the edge of the doorway.

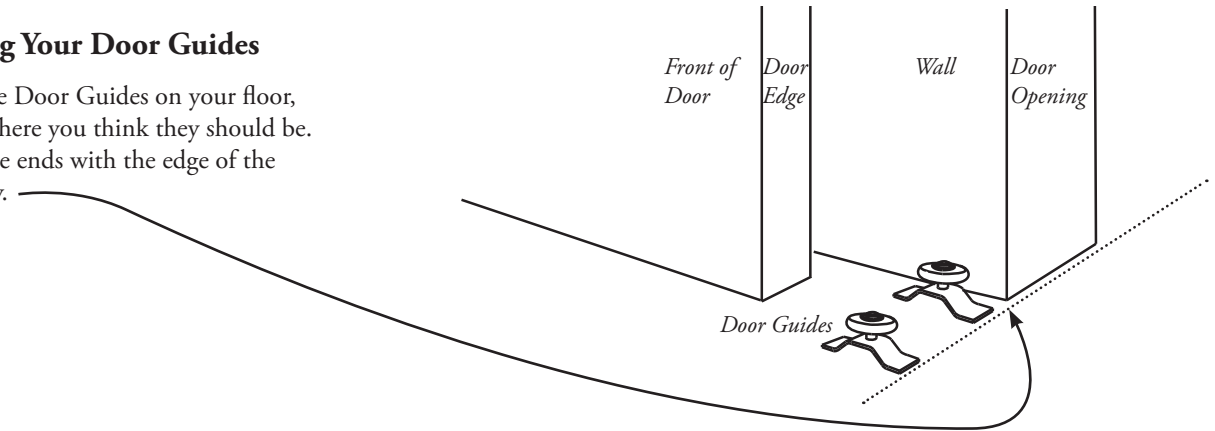

2. Aligning Door Over Door Guides

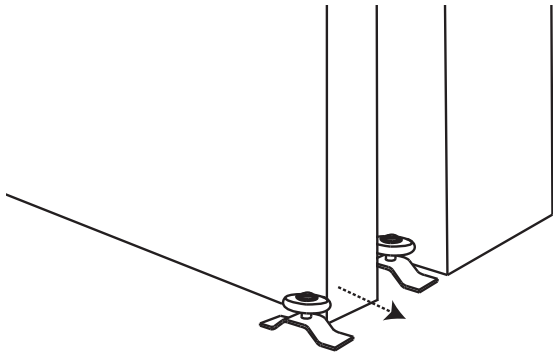

- Pull the Door in between the Brackets. Use a level to ensure your Door is vertically plumb.
- When you have your Door Guides in the proper location, carefully roll your Door back.



3. Attaching Door Guides

- Hold your Door Guides in place while you carefully use a Drill with a Phillips bit and attach Door Guides with Grabber Screws.

